

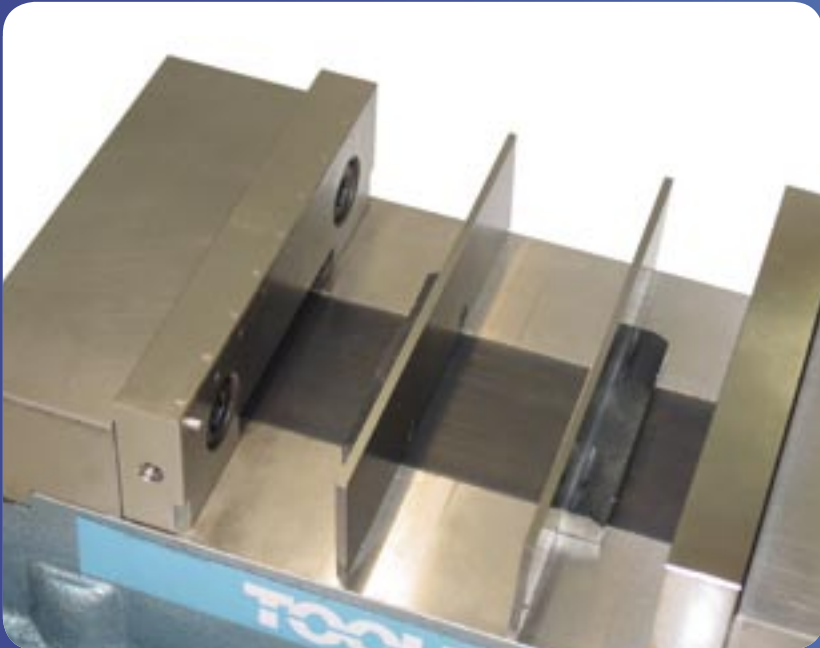

**DON'T FORGET THE
WORKHOLDING!**



NEW! Locator Jaw Parallel System

**with built-in workstop
pins for 6" single
station vises**



***Save time
and money!***





NEW Locator Jaw Parallel System

**with built-in workstop pins
for 6" single station vises**

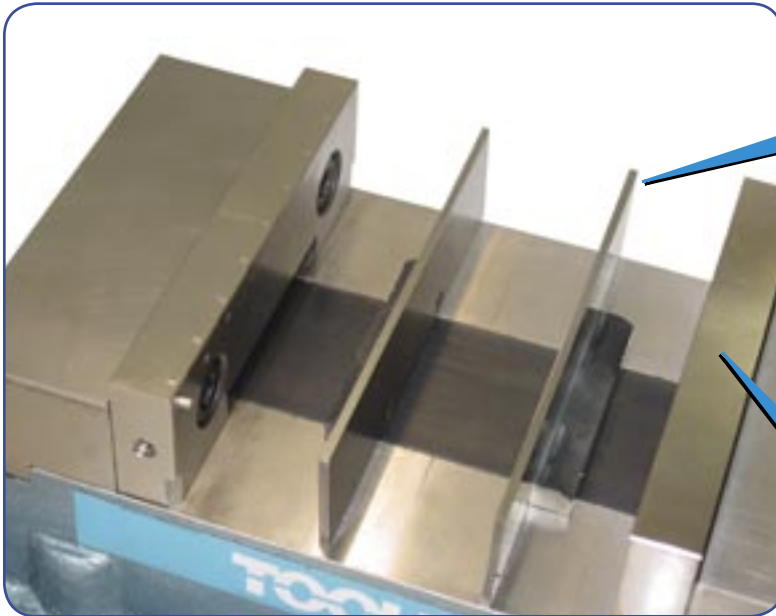

*Parallels literally
snap in and out for
quick set-ups!*

*Simply bolt the
master jaws to your
existing vise!*



*Locating pins push
in and out to
accurately locate
your part. No-guess
repeatability!*

MAKE YOUR JOB FASTER AND EASIER!

*You'll save both time AND money with the new
Locator Jaw Parallel System from TE-CO!*

Contact us today for your FREE Master Catalog

800-543-4071 www.te-co.com

2-piece Master Jaw Set

Part #TLJ6000: **\$150.00**

Set includes one plain master jaw (no pins) and one jaw with locating pins.

Just bolt them on to your existing vise!

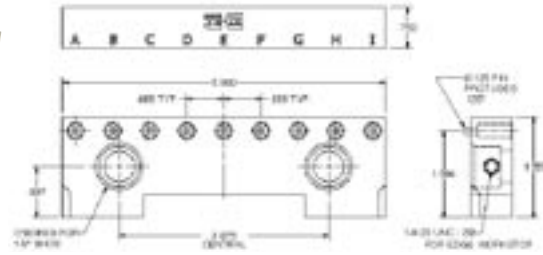

Individual Parallels

Parallels snap into position quickly and easily!



Part Number	A	B	C	Price
TLP6001	.750	5.980	.125	\$49.75
TLP6002	1.000	5.980	.125	\$49.75
TLP6003	1.125	5.980	.125	\$49.75
TLP6004	1.250	5.980	.125	\$49.75
TLP6005	1.375	5.980	.125	\$49.75
TLP6006	1.500	5.980	.125	\$49.75

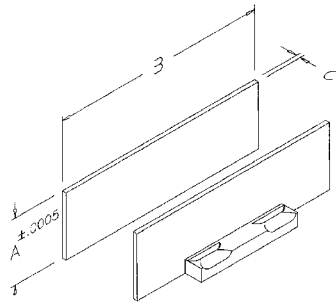

Use in conjunction with **TE-CO Locator Master Jaws**

Basic Parallels Set

Part No. TPS6000:

\$199.00



Set includes 4 pairs of parallels (one pair each of the following heights): 3/4", 1", 1-1/4" & 1-1/2".

TOOLEX[®]
VISE WORKHOLDING SYSTEMS

6" Single Station Vise



Compatible with Locator Jaw Parallel System, as well as both QuickChange™ and AccuSnap® jaws and parallels!

Part No. RWS6001S

- Includes hard jaws, removable chip shield, and cast iron handle.
- 7.5" maximum jaw opening.
- Bed height of 2.875" (73.025 mm)
- Non-lifting movable jaw design.
- Powder coated finish for durability and coolant resistance.
- Stress relieved 80,000 psi ductile iron vise body and flame hardened bed

LIST PRICE: \$375.00

4 jaw configurations offer additional holding capacity

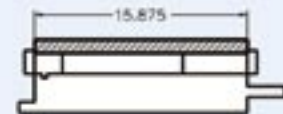
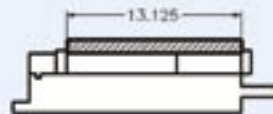
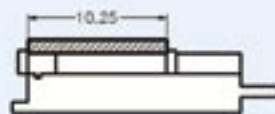
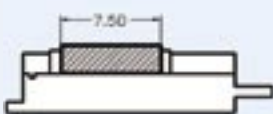

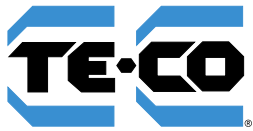

FEATURED PRODUCTS

CMM FIXTURING

1/4-20 Modular CMM Fixturing

Build repeatable setups in minutes!

Available Components:

- Aluminum CMM Fixture Plates
- Soft Touch Clamps
- Standoffs and Rest Pads
- Magnetic Rest Pads and Vees
- CMM Fixturing Towers

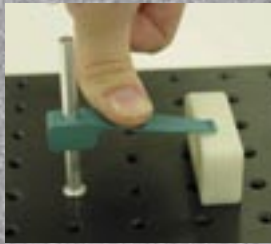

Soft Touch Clamp actuates with the press of a finger

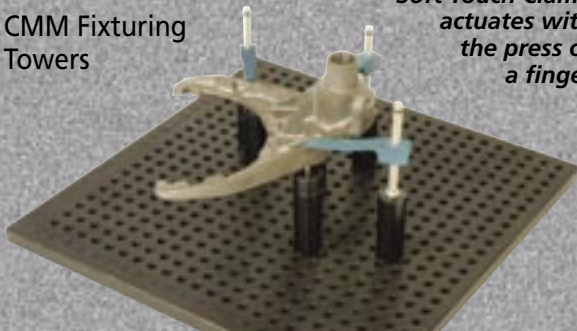

SPRING & BALL PLUNGERS

Expansive Line of Spring and Ball Plungers

Ideal for Locating, Positioning, and Fastening

- Spring Plungers
- Short Spring Plungers
- Ball Plungers
- Press Fit Plungers
- Hand Retractable

Contact us for a quote



TOOLEX VISES

Increase Spindle Time, Accuracy and Flexibility

- Manual and Hydraulic available in 4" and 6" systems
- 8" system available for large workpieces
- Vise bodies are manufactured from high tensile ductile cast iron
- Unique SnapLock™ Jaw design allows quick jaw changeover in seconds
- Precision ground for accuracy and repeatability

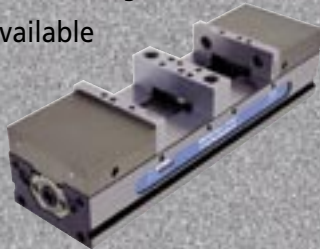

TOOLEX
VISE WORKHOLDING SYSTEMS

TOOLEX PARALLEL SYSTEMS

AccuSnap® and QuickChange™ Jaw and Parallel Systems

Adaptable to Most Vises

AccuSnap parallels and jaws "snap" into position, with repeatability of +.0002.

Available in 4", 6" & 8" sizes

QuickChange parallels and jaws "slide" into position via dovetail design.



TE-CO 109 Quinter Farm Rd. Union, OH 45322

Phone: 800-543-4071 Fax: 937-832-1274

www.te-co.com www.toolexvises.com

ISO 9001
CERTIFIED